















Siebventil 1 1/4" - Champagne gebürstet (22kt Gold)

IMO

10 110 970



Passt zu: IMO, LULU, MADISON, MEM,
TARA, CL.1, LISSÉ, VAIA, META, CYO

| | | |
|---|---------------------------------|---------------|
|  | Champagne gebürstet (22kt Gold) | 10 110 970-46 |
|  | Chrom | 10 110 970-00 |
|  | Platin gebürstet | 10 110 970-06 |
|  | Platin | 10 110 970-08 |
|  | Messing (23kt Gold) | 10 110 970-09 |
|  | Dark Chrome | 10 110 970-19 |
|  | Light Gold | 10 110 970-26 |
|  | Light Gold gebürstet | 10 110 970-27 |
|  | Messing gebürstet (23kt Gold) | 10 110 970-28 |
|  | Schwarz matt | 10 110 970-33 |
|  | Bronze gebürstet | 10 110 970-42 |
|  | Champagne (22kt Gold) | 10 110 970-47 |
|  | Chrom gebürstet | 10 110 970-93 |
|  | Dark Platinum gebürstet | 10 110 970-99 |



Siebventil 1 1/4" - Champagne gebürstet (22kt Gold)

IMO

10 110 970

Nur für Becken ohne Überlauf geeignet.

10 110 970

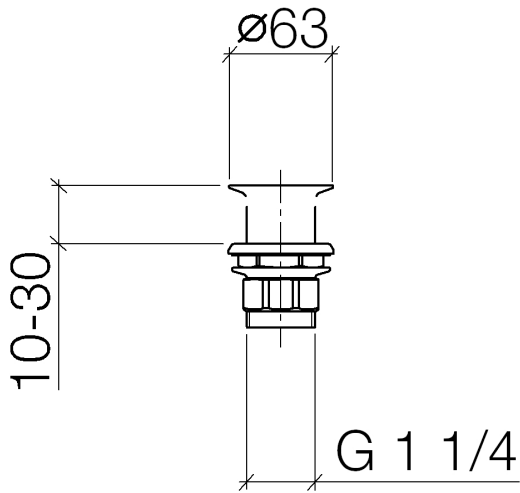

10 110 970

Ersatzteile für die
anderen
Oberflächenvarianten
finden Sie hier:
Chrom

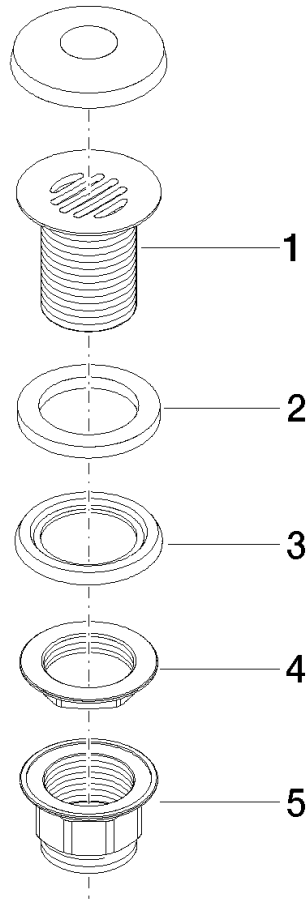

Ersatzteilstückliste

| Nr. | Artikelnummer | Benennung | Verbaumenge | Lieferzeit |
|-----|-----------------|-----------|-------------|------------|
| 1 | 09 11 01 025-46 | Kelch | 1 | 30 |
| 2 | 09 14 05 039 90 | Dichtung | 1 | 2 |
| 3 | 09 14 03 025 90 | Dichtung | 1 | 2 |
| 4 | 09 23 10 017 90 | Mutter | 1 | 2 |
| 5 | 09 23 10 020-46 | Mutter | 1 | 30 |